

# Willoughby Locking Systems

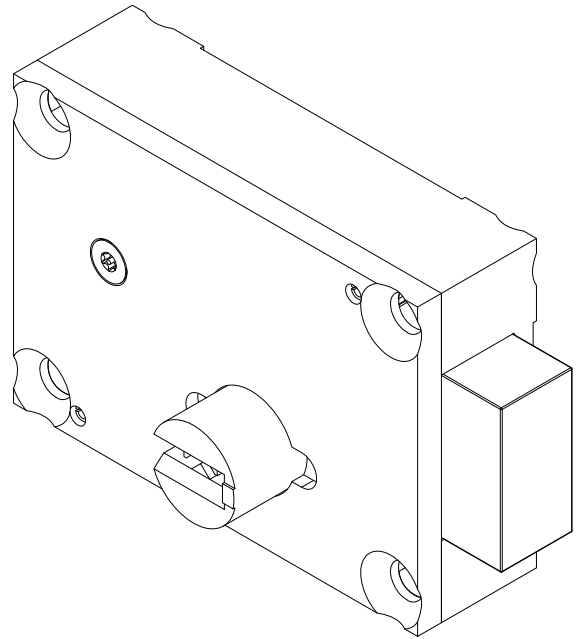

## WLS-1710 Stainless Steel Food Pass Deadbolt Lock



### Recommended Specifications

The WLS-1710 series deadbolt lock is used in high security applications for food pass doors, observation panels and other small doors in Governmental and Industrial buildings. The WLS-1710 series uses a paracentric cylinder and key.

The WLS-1710 is not recommended as the a primary means of securing a full door or when dead latching is a requirement.

#### **Standard lock shall include:**

- High security and impact resistant
- 5/8" bolt throw
- Deadbolt size is 1-1/2" x 3/4"
- Lock case, cover and latch are constructed from cast stainless steel utilizing hardened brass key, cylinder and tumblers
- Lever tumblers are designed with 'anti-pick' notches for both the locked and unlocked positions
- Key-way depths are designed to impede of 'picking' of locks
- Key is made of bronze alloy and machined to fit smoothly into lock (sold separately)
- Lock can be Surface Mounted with 4 security screws or Hollow Metal Flush Mounted with 7ga. Mounting Plate and 6 security screws (hardware included with lock)

**To specify fixture and accessories, use the Model Number and Options page.**

Example: To specify a stainless steel food pass deadbolt lock, keyed one side and left hand reverse.

Use the following Willoughby Model Number:  
**WLS-1710-K1-LHR**



**WARNING:** Cancer and Reproductive Harm

- [www.P65Warnings.ca.gov](http://www.P65Warnings.ca.gov)

visit our website at [www.willoughby-ind.com](http://www.willoughby-ind.com)  
5105 West 78th Street • Indianapolis, IN. 46268  
(317) 875-0830 • Fax: (317) 875-0837 • (800) 428-4065



MADE IN THE U.S.A.

# MODEL NUMBER AND OPTIONS:

**1.) Model Number:**

- WLS-1710 Stainless Steel Food Pass Deadbolt Lock

**5) Mounting:**

- HM Flush Mount 7ga. Stainless Steel Plate for Hollow Metal Doors
- SM Surface Mount

**2) Keyed:**

- K1 Keyed One Side
- K2 Keyed Both Sides
- Other \_\_\_\_\_

**3) Lock Handing (See handing chart on next page):**

- LH Left Hand Lock (In-swing Door)
- RH Right Hand Lock (In-swing Door)
- LHR Left Hand Reverse Lock
- RHR Right Hand Reverse Lock

**4) Escutcheon:**

- EC1 1-Way Escutcheon
- EC2 2-Way Escutcheon

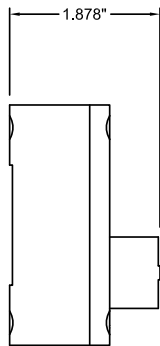
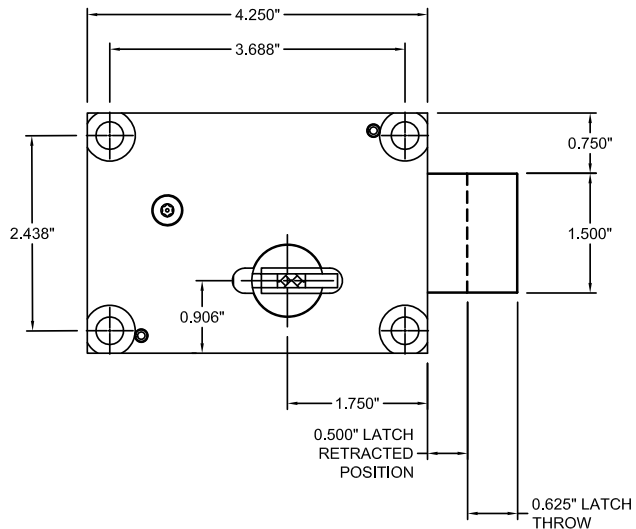
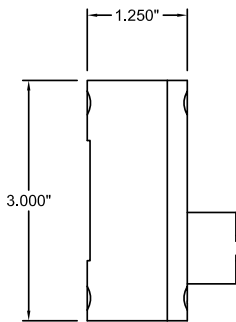

**K1**

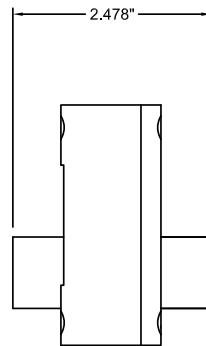

**K2**

**DRAWINGS ARE FOR REFERENCE ONLY, CONTACT FACTORY TO VERIFY DIMENSIONS**

WILLOUGHBY RESERVES THE RIGHT TO MAKE CHANGES IN DESIGN AND DIMENSIONS WITHOUT FORMAL NOTICE AND WITHOUT INCURRING OBLIGATION.

*visit our website at [www.willoughby-ind.com](http://www.willoughby-ind.com)*  
 5105 West 78th Street • Indianapolis, IN. 46268  
 (317) 875-0830 • Fax: (317) 875-0837 • (800) 428-4065



MADE IN THE U.S.A.

**ADDITIONAL INFORMATION:**

**LOCK HANDING CHART**

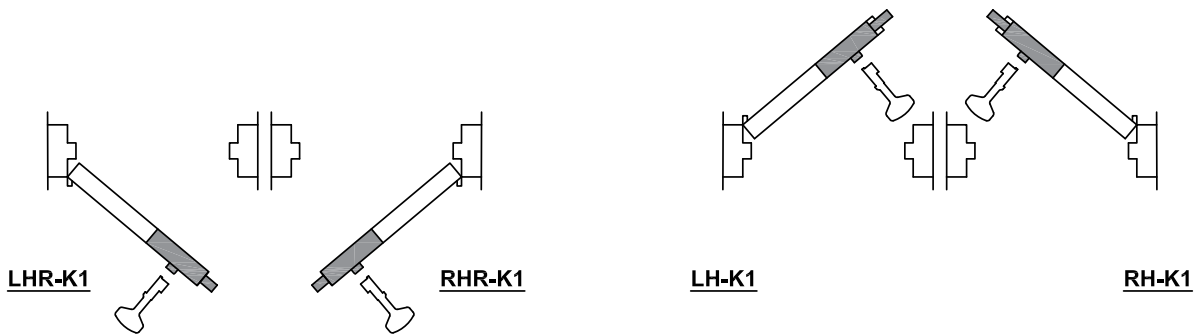

**KEYED K1 HINGED SIDE**  
HOLLOW METAL MOUNTING PLATE  
(FOR OUT-SWING DOORS)

**KEYED K1 STOP SIDE**  
HOLLOW METAL MOUNTING PLATE  
(FOR IN-SWING DOORS)

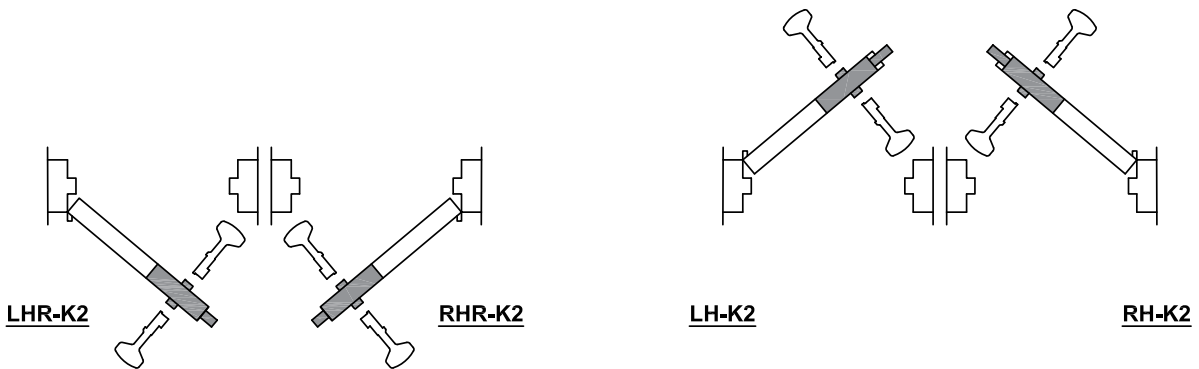

**KEYED K2**  
HOLLOW METAL MOUNTING PLATE  
(FOR OUT-SWING DOORS)

**KEYED K2**  
HOLLOW METAL MOUNTING PLATE  
(FOR IN-SWING DOORS)

visit our website at [www.willoughby-ind.com](http://www.willoughby-ind.com)  
5105 West 78th Street • Indianapolis, IN. 46268  
(317) 875-0830 • Fax: (317) 875-0837 • (800) 428-4065



MADE IN THE U.S.A.